

SmartOffice S60

❖ SOFTWARE



DocAction

Plustek DocAction

Button utility to simplify document scanning. DocAction enables you to specify your personalized scanning configuration settings and scan documents with the click of a button. Scanned documents are automatically sent directly to Printer, Email, Folder or FTP. DocAction also enables you to scan directly to many imaging and document management applications. DocAction saves scanned documents in all common imaging formats including JPEG, TIFF, and PDF.

❖ BUILT-IN OCR



Plustek OCR

Plustek OCR^[1]

Plustek OCR (Powered by ABBYY® FineReader®) helps to convert scanned paper documents, photos, and PDF files into editable formats. With Plustek OCR, you can convert paper documents to editable formats, including Microsoft® Word®, and Excel®, edit resulting documents, and reuse their text and other content.

Hardware Requirements

3.2 GHz CPU processor or higher^[1]
 [1]Windows Recommended: 3.2 GHz Intel® Core™ i7 Processor with 4 CPU Cores or higher
 4 GB RAM minimum (Recommended: 8 GB or more)
 6 GB of hard-disk space for program installation
 Display dimensions of 1024x768 or greater



Specification

Hardware Resolution	600 x 600 dpi
Scan Modes	Color: Input 48-bit, Output 24-bit Grayscale: Input 16-bit, Output 8-bit Black & White: 1-bit
ADF Capacity	1. 100 sheets (A4/ Letter, 70 g/m ² or 18 Lbs), Max. thickness under 10 mm (0.4") 2. 50 sheets (A3, 70 g/m ² or 18 Lbs) 3. 20 sheets (Business Cards) 4. Plastic Card (Landscape Loading), Max. thickness under 1.2 mm, embossed cards can be scanned. Note: Maximum ADF capacity varies, depending upon paper weight.
Scanning Speed (ADF)	64 ppm/ 128 ipm (Color mode, 300 dpi, A4 Landscape) 48 ppm/ 96 ipm (Color mode, 300 dpi, A4 Portrait) 36 ppm/ 72 ipm (Color mode, 300 dpi, A3) Note: Results may vary depending upon your scanning application, computer processor and system memory.
Scanning Area (W x L)	Max: 304.8 x 431.8 mm (12" x 17") Min: 50.8 x 63.5 mm (2" x 2.5") Long Paper: 304.8 x 5080 mm (12" x 200")
Acceptable Paper Sizes (W x L)	Max: 304.8 x 431.8 mm (12" x 17") mm Min: 13.2 x 13.2 mm (0.52" x 0.52")
Acceptable Paper Weight (Thickness)	40 to 220 g/m ² (10 to 58 Lbs)
Multi-feed Detection	With ultrasonic technology
Daily Duty Scan (Sheets)	18,000
Separate Roller Lifetime (Scans)	300,000
Pick Roller Lifetime (Scans)	300,000
Friction Roller Lifetime (Scans)	100,000
Action Button	5 Buttons: Power, Up, Down, Cancel, Scan 9 function keys are all customizable.
Power Supply	24 Vdc/ 1.25 A
Interface	USB 3.2 Gen 1x1
Net Weight	6.8 Kgs (14.99 Lbs)
Dimensions (W x D x H)	436 x 262 x 266 mm (17.16" x 10.31" x 10.47")
Protocol	TWAIN Compliant
Operating System	Windows 7 / 8 / 10 / 11

[1]ABBYY® FineReader™ © ABBYY. OCR by ABBYY. ABBYY and FineReader are trademarks of ABBYY Software, Ltd. which may be registered in some jurisdictions.
 Any other products or company names appearing in this document are the trademarks or registered trademarks of the respective companies.



SmartOffice Series

SmartOffice S60



A Versatile, Ultra-compact A3 Production Scanner



The Plustek SmartOffice S60 A3 duplex document scanner raises productivity for high-volume working environments. Featuring high speeds of up to 64 ppm/ 128 ipm and daily duty cycle up to 18,000 sheets, it combines exceptional performance and reliability with a sleek, compact design. Normal/thin paper switch allows users to scan a wide range of document types with different thickness, preventing them from multi-feed errors. An included TWAIN driver provides seamless integration with standard applications and software systems. Enjoy the option of keeping the scanner in a storage position after use.

❖ KEY FEATURES

- **Fast scanning speeds and imaging technologies** — up to 64 ppm/128 ipm (A4 Landscape) with one-pass duplex scanning
- **Large volume document processing** — a robust capacity of Auto Document Feeder (ADF) that holds up 50-page A3 size or 100-page A4 size
- **Reliable quality** — upgraded features including pick roller, separate roller, paper stopper frame, paperweight, programmable jobs and a peak daily duty cycle of up to 18,000 sheets
- **Compatibility with software and document management systems** — included TWAIN driver for easy integration with existing applications
- **High performance and productivity** — auto-rotation, auto-crop, auto-deskew, blank page removal, and "Cancel" button for paper protection
- **Scan to FTP function** — sending data to your storing destinations easily with easy-to-use software Plustek DocAction
- **Creation of Searchable PDFs** — making scanned content immediately accessible and editable with Plustek OCR (Powered by ABBYY® FineReader®)
- **Versatile paper handling** — business cards, ID cards, single sheets, extra long papers up to 200", and documents up to 12" x 17"

www.plustek.com



Versatile Media Handling

S60 has paper-handling flexibility to meet a variety of scanning environments. Switching to Sheetfed Mode allows you to scan bound, folded documents such as passport easily and safely. Switching to ADF Mode allows you to scan multiple pages in a row and perform heavy duty jobs quickly.



Scanning from Thin to Thick

Supporting different paper thickness, S60 enables you to scan various business documents without concerns. It can be switched between Normal Mode and Thin Paper Mode to prevent picking failure, paper jam and damage effectively.



Ultrasonic Multi-feed Detection

With outstanding reliability, S60 prevents multi-feeds by accurately measuring paper thickness and detecting overlapped pages passing through the scanner with the built-in ultrasonic sensor. This function can be turned off when scanning documents with labels, sticky notes, or taped receipts.

Adjustable chassis design

Designed with compact size and versatility, S60 has 3 positioning methods for different needs. Storage Mode provides better mobility and smaller footprint. Normal Mode is perfect for batch scanning. Special Mode runs smoothly for fragile document and extra-long papers.

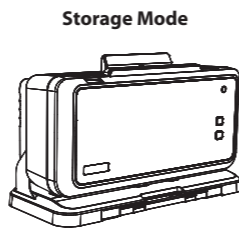
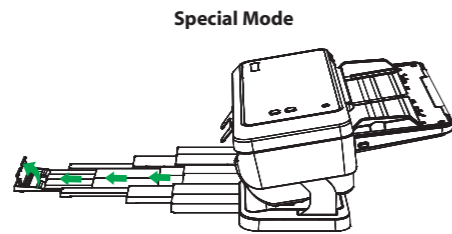
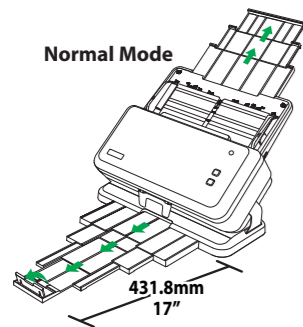

1 Auto Threshold

Automatically threshold the current image into a binary black and white image.

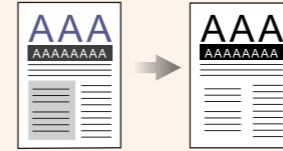

2 Auto Rotate

Automatically rotates document based on the contents of the document.

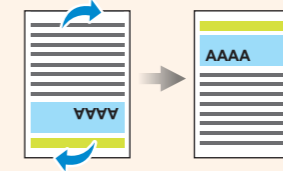

3 Auto Crop & Deskew

Automatically straightens and crops image to the documents actual size.

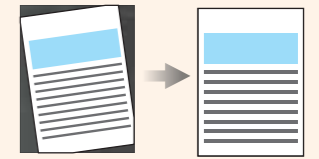

4 Auto Color Mode

Automatically detects document color and scans document in color, grayscale or black & white mode.

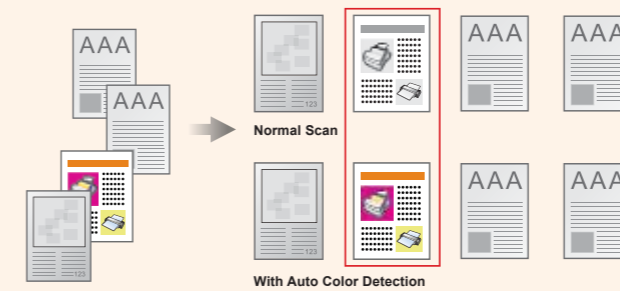

5 Multi-Image Output

Scans and saves documents in 2 or 3 color modes at same time.

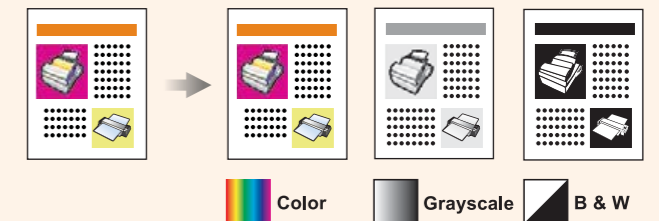

6 Color Dropout

Removes red, green or blue color when scanning forms.



7 Blank Page Removal

Automatically removes blank pages without manual editing.

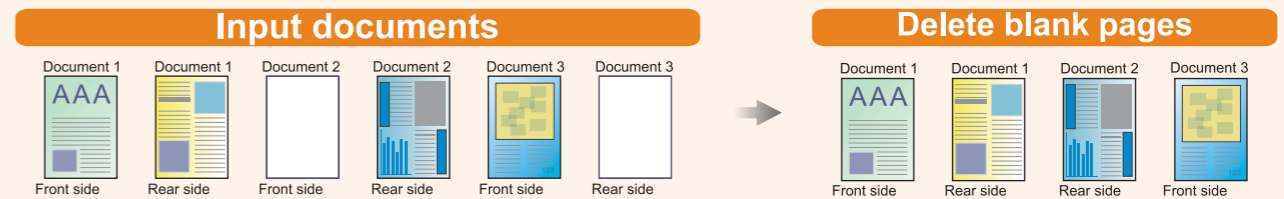

64^{PPM}
128^{IPM}

fast duplex scanning at speeds up to 64 pages per minute in color mode

100
pages

Effective scanning with large Automatic Document Feeder up to 100 pages



Scans stapled documents or passport. Perfect for vertical applications such as healthcare, pharmacy, accounting, hospitality, etc.



High speed interface and data transfer. Supports USB 3.0 for high speed data transfer between scanner and the computer.



Scans embossed rigid cards such as ID cards, insurance cards, drivers licenses and credit cards up to 1.2mm



Save paper documents as searchable PDFs at the touch of a button and find your information faster